

Collection 005 Change Summary for the MODIS Cloud Optical Property (06_OD) Algorithm

Version 3.1 (9 May 2006)

*Dr. Michael D. King, Dr. Steven Platnick,
Paul A. Hubanks, G. Thomas Arnold, Eric G. Moody, Gala Wind, and Brad Wind*

High Impact Change Overview:

The most significant Collection 005 changes are (in no particular order):

- Improved cloud phase algorithm
- Improved ice libraries
- New clear sky restoral algorithm (for flagging heavy aerosol and sunglint)
- New surface albedo maps

Change Details:

A summary of changes implemented in the Collection 005 version of the algorithm is given below. High impact code changes (see above) are presented first.

Structural Changes

- **Modular structure.** All Fortran 77 code and structures have been re-written in Fortran 90, greatly improving code design and maintenance.

High Impact Changes – General Improvements

- **Cloud phase algorithm.** Shortwave Infrared (SWIR) reflectance ratio thresholds have been updated. The shorter wavelength (approximately non-absorbing) band used to define the ratio now depends on the underlying surface type. A separate set of thresholds is used for snow and ice surfaces, as well as for optically thick clouds. Also for Collection 005, SWIR ratio tests are only run when the cloud is thought to be thick enough to cause appreciable liquid/ice SWIR absorption differences. Logic for incorporating the IR phase retrieval result has been modified, in particular the use of the 1.38 μm cloud mask test for undetermined phase clouds. *Sanity checks* for cold clouds (force to ice phase when cloud top temperature $T_{\text{cloud top}} < 233$ K) were deleted due to possible bias for optically thin cirrus clouds; the warm *sanity check* (if $T_{\text{cloud top}} > 273$ K then set to liquid water) was retained but only when SWIR ratio tests are used. [For detailed logic flow, see Diagrams 1, 2, and 3 at end of document.]
- **Ice libraries.** New ice-crystal size/habit distribution cloud models were used to generate an improved ice reflectance library (Baum et al., 2005). Effective radii are now evenly spaced at $r_e = 5, 10, 15, 20, 25, 30, 35, 40, 45, 50, 55, 60, 90$ μm . The new libraries affect the cloud retrievals in several ways. First, the library scattering parameters are now monotonic as a function of effective radius. In particular, there is a marked reduction in the failure of the 3.7 μm ice cloud effective radius retrievals. The default (standard) 2.1 μm effective radius retrievals are reduced by a few micrometers relative to Collection 004 libraries. Second, the new libraries now allow for a retrieval in excess of 60 μm , though this has been found to be a rare oc-

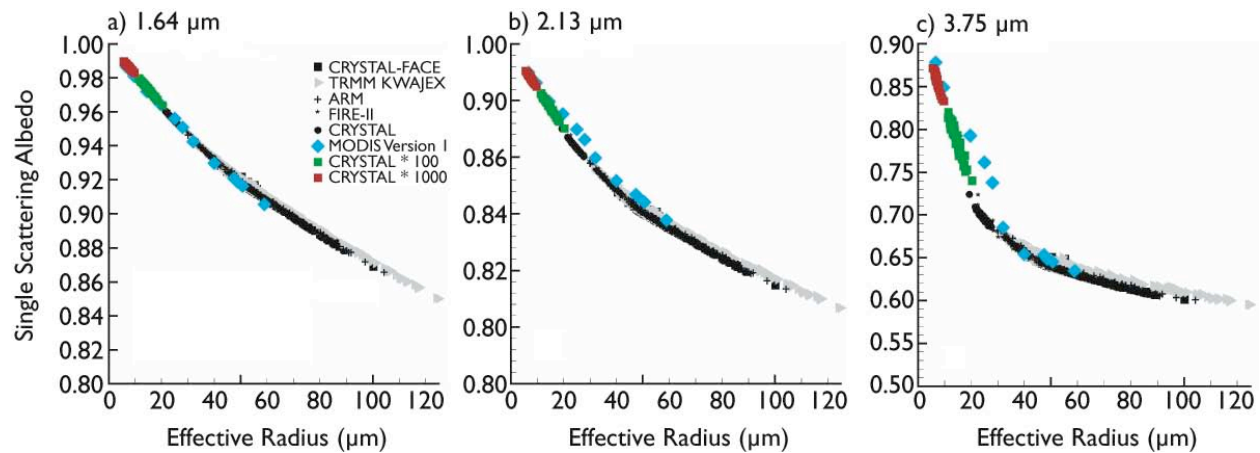

Figure 1. MODIS band-averaged single scattering albedo calculated from in situ particle size distributions assuming a mixture of ice particle habits. Superimposed on the data are the results from a sensitivity involving the CRYSTAL-FACE particle size distributions in which the number of particles with sizes less than $20\ \mu\text{m}$ were multiplied by a factor of 100 (green symbols) or multiplied by a factor of 1000 (red symbols). The twelve MODIS version 1 models (Collection 004) are superimposed for reference (blue symbols) (after Baum et al. 2005).

currence. It should be noted that this change affects the Level-2 and Level-3 range of Cloud Effective Radius and Cloud Water Path for ice clouds, where the Collection 004 solution range was approximately *6 to 60* and *0 to 4000*, respectively. For Collection 005, the solution range of Cloud Effective Radius and Cloud Water Path for ice clouds is *5 to 90* and *0 to 6000*, respectively. [For an example of the ice cloud single scattering albedos of the new and old ice libraries, see Figure 1.]

- New clear sky restoral algorithm.** Implemented a *Clear Sky Restoral* (CSR) that attempts to identify pixels that are poor retrieval candidates, i.e., those that are likely to have been incorrectly identified as cloud and partly-cloudy pixels. Pixels so identified are “restored” to a clear sky designation and assigned a retrieval “fill value”. The new algorithm includes a dual-threshold spatial variability test (constrained by $1.38\ \mu\text{m}$ reflectance, cloud phase, and spectral tests), a 250 m partly-cloudy test over the ocean, and cloud edge detection. The spatial variability test seeks to remove dust, smoke, snow/ice, and sunglint, while the 250 m and edge detection tests attempt to remove partly cloudy pixels. The CSR QA bit values are set as follows: 0 if CSR tests were either not run or all CSR tests were negative; 1 if the spatial and 250 m tests are negative, and the edge test is positive; 2 if the spatial test is positive and the 250 m test is negative (edge test not run); 3 if the 250 m test is positive, regardless of the outcome of the spatial test (edge test not run). [For detailed logic flow, see Diagrams 4 and 5 at end of document. Figure 2 shows an example of this new flag].
- Partial Retrievals.** In Collection 004, a failed effective radius retrieval (i.e., the measured absorbing band reflectance could not be matched with a reflectance library value for the allowable range of optical thicknesses) resulted in both the optical thickness as well as the effective radius retrievals being set to the fill value. In Collection 005, the effective radius is still set to the fill value but an optical thickness is provided assuming an effective radius of 10 and $30\ \mu\text{m}$ for liquid water and ice clouds, respectively. This partial retrieval (optical thickness only) should be used cautiously as it may be indicative of a partly cloudy pixel, a clear sky pixel, an incorrect phase, etc. The optical thickness from a partial retrieval is not aggregated by the Level-3 algorithm. [Figure 3 shows an example of partial retrievals for a Terra granule near Trinidad & Tobago in the southern Caribbean Sea on February 21, 2001].

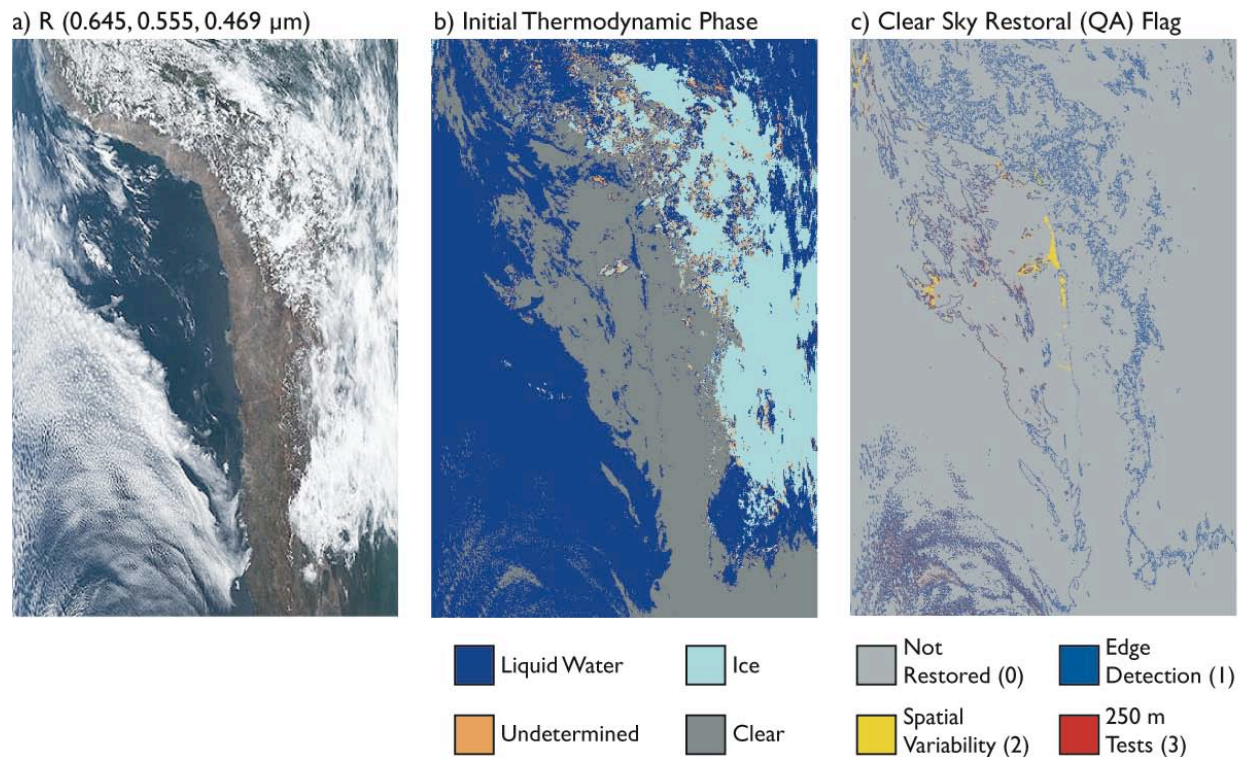

Figure 2. Clear Sky Restoral. Panel (a) is a true color composite of a Terra MODIS granule off Peru on February 12, 2001 at 15:10 UTC. Panel (b) is the initial assessment of which pixels are clear and which are cloudy, and their thermodynamic phase. Panel (c) is the new Collection 005 Clear Sky Restoral Flag that is stored in the Cloud Optical Properties QA Flag array (Quality_Assurance_1km SDS). This flag indicates whether a pixel originally determined to be cloudy is thought to be clear sky or partly cloudy based on further tests applied in the *Clear Sky Restoral* algorithm. Pixels with a flag value not equal to zero are “restored” to clear and the cloud retrieval is set to fill (missing).

High Impact Changes – Albedo Dataset Improvements

- **Improve snow-free surface albedo maps.** A newly developed high-resolution spatially complete snow-free surface albedo dataset was added. This dataset was created by employing an ecosystem-dependant temporal interpolation technique to fill missing or seasonally snow-covered data in the operational MODIS Terra land surface product (MOD43B3), as described in Moody et al. (2005). An aggregation using 5 years (2000-2004) of MOD43B3 data was used for the final Collection 005 delivery (Moody et al. 2006a). This dataset is stored in equal-angle grids for ease-of-use and has high temporal (16 day) and spatial (2 km) resolution for all MODIS bands of interest. Consequently, seasonal, spectral, and spatial variations of surface albedos are now more accurately represented (see Figure 4).
- **Snow and ice albedo.** In Collection 004, the spectral albedo of sea ice and snow-covered land was hardwired to fixed values irrespective of surface conditions or location. In Collection 005, snow/ice albedos are derived from the MOD43B3 spectral surface albedo product (~1 km, 16-day product) and the MOD12Q1 ecosystem classification map; the extent to which the ecosystem map is used depends on location. As with Collection 004, snow/ice scenes are identified with the snow/ice index from NOAA’s microwave-derived daily 0.25° Near Real-Time Ice and Snow Extent (NISE) dataset. Details on how spectral albedos are derived for permanent snow, snow over land, sea ice, and coastal ice are summarized below.

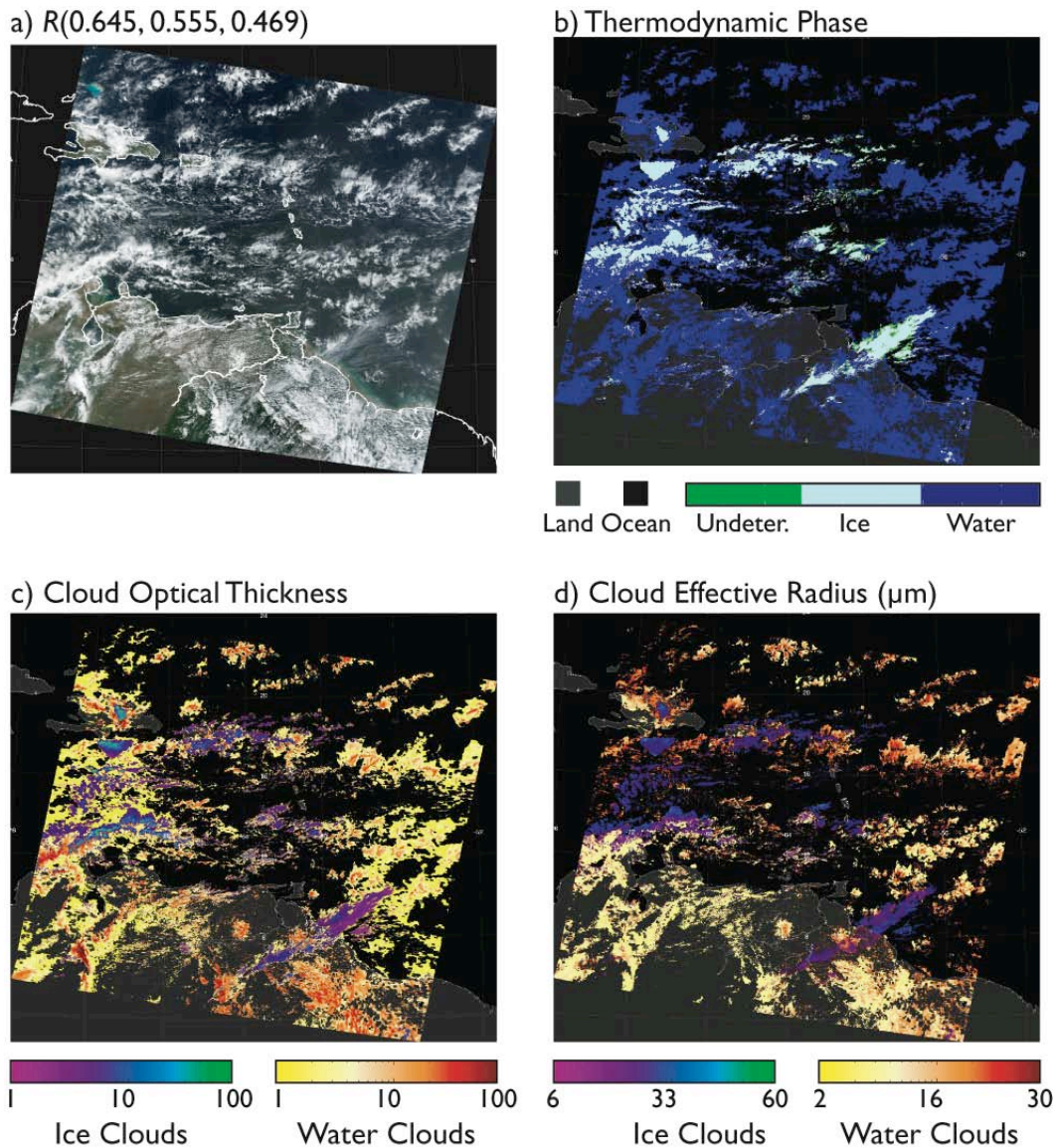

Figure 3. Cloud optical thickness and effective radius retrieved from Terra MODIS data on February 12, 2001 over the Caribbean Sea and northern South America. This figure shows (a) the true color image showing a region of cumulus humilis clouds over the ocean, (b) the thermodynamic phase of all clouds identified for this scene, (c) the cloud optical thickness of liquid water and ice clouds, and (d) cloud effective radius of all liquid water and ice clouds. Panels (b) and (c) show the widespread occurrence of optically thin liquid water clouds of the Caribbean, while panel (d) shows fewer successful effective radius retrievals.

Albedo for non-permanent snow on land. Albedos for non-permanent snow on land surfaces are taken from lookup tables populated by MOD43B3 albedos aggregated according to MOD12Q1 ecosystem classifications. The lookup table provides hemispherical seasonal multi-year averages and, as such, is intended to represent albedos for “average” snow conditions for a given ecosystem in a particular hemisphere. Five years (2000–2004) of high quality MOD43B3 data flagged as snow-covered land were used in the aggregation; NISE data were used as an additional discriminator of snow extent (cf. Moody et al. 2006b). [Figure 5](#) shows plots of the multi-year hemispherical snow albedo means for MODIS computed from Collection 004 2000–2004 MOD43B3 data. [Figure 6](#) shows a global map for a 16-day period beginning on January 1 for MODIS band 2. Significant differences in spectral albedo are seen across the ecosystems in both figures.

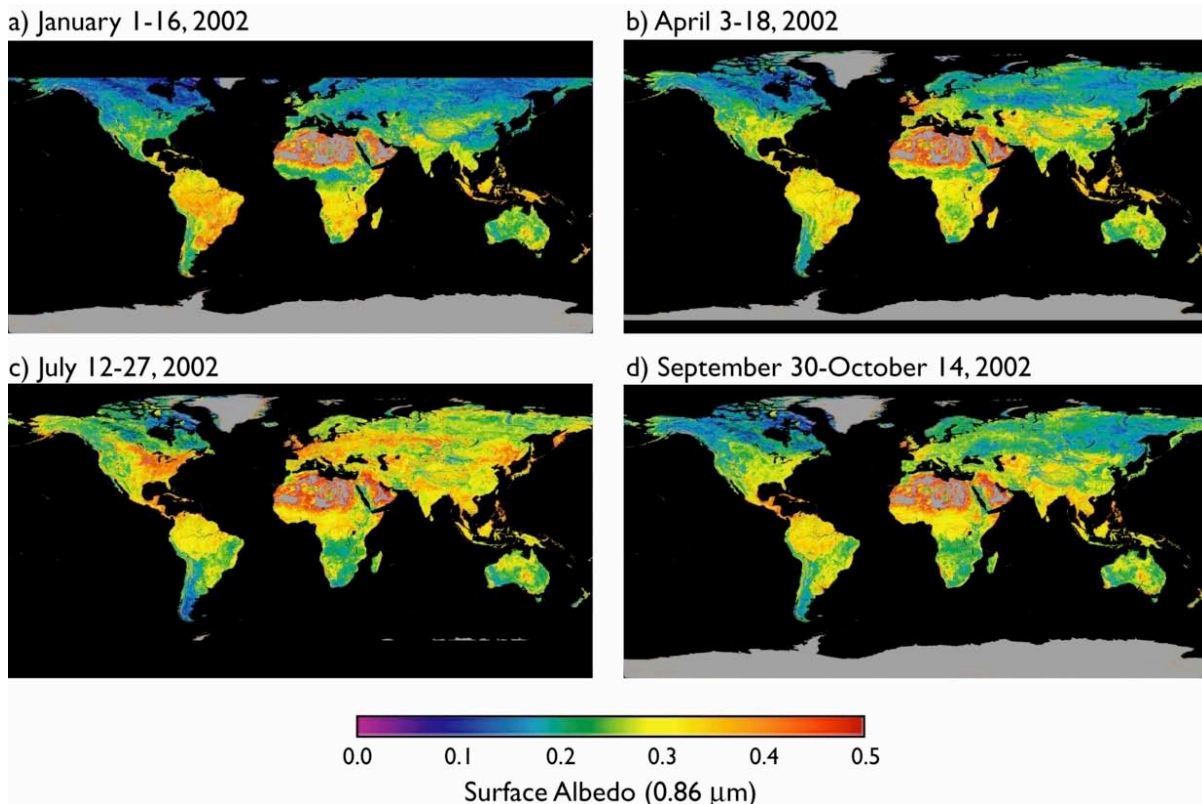

Figure 4. Spatially complete white-sky albedo at 0.86 μm after the temporal interpolation technique was applied for the 16-day periods of (a) January 1-16, (b) April 3-18, (c) July 12-27, and (d) September 30-October 14, 2002 (after Moody et al. 2005).

Albedo for permanent snow. For land locations associated with permanent snow by the MOD12Q1 ecosystem map (e.g., Greenland, Antarctica), the MOD43B3 product is used directly. Therefore, unlike the seasonal five-year average lookup table used for snow on other land types, permanent snow albedos can show significant spatial and temporal variability (depending on spectral band and season). NISE also has a permanent snow index; if NISE identifies a location as permanent snow while MOD12Q1 does not, the multi-year average albedo for permanent snow from the lookup table is used (see above paragraph). Note that the permanent snow albedo statistics in the lookup table are not differentiated by hemisphere.

Albedo for sea ice. The NISE data set gives fractional sea ice coverage. Spectral albedos for unity sea ice fraction are taken from the snow statistics lookup table for permanent snow. Albedos for non-unity fraction are a linear average between the permanent snow values and open-ocean albedos. A temporal interpolation is used to estimate melt season transitions; minimum melt season albedos are set to 80% of the permanent snow values with a linear interpolation between the two applied over a 10 day period on either side of the melt season. The Northern Hemisphere (NH) melt season is defined as being from June 1 through September 1; the Southern Hemisphere (SH) melt season is December 1 through March 1. For comparison, the Collection 004 NH melt season was the same but the SH melt season was specified as September 1 through June 1. Further, Collection 004 did not include a melt season transition period, but instead prescribed an abrupt change in albedo. As an example, the Collection 004 melt season albedo for the 1.2 μm MODIS band was 0.25 vs. 0.45 otherwise; the minimum Collection 005 melt season value is 0.356 vs. 0.445 otherwise.

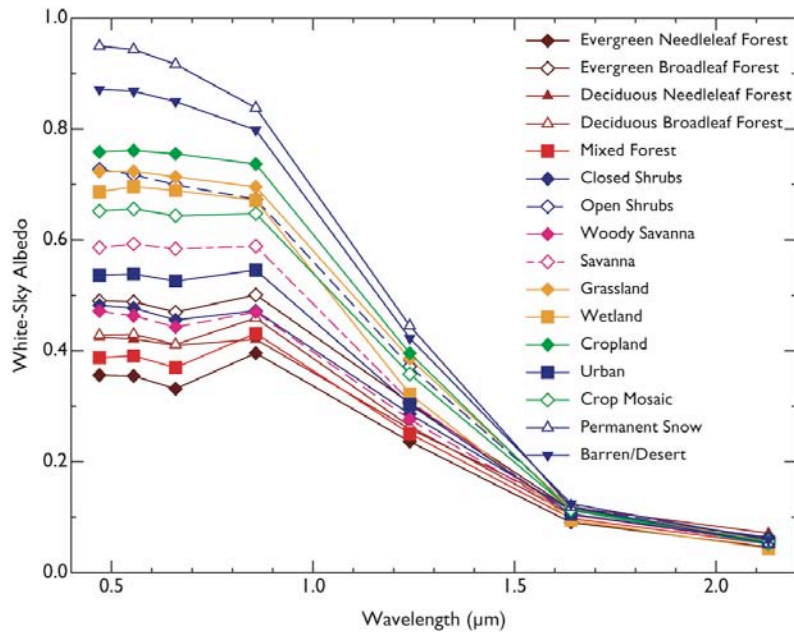

Figure 5. Northern hemisphere multi-year average white-sky spectral snow albedo as a function of select IGBP ecosystem classifications from 2000-2004 MOD43B3 data (after Moody et al. 2006b).

Albedo for snow/ice in coastal regions. Due to the limitations of microwave retrievals, the NISE data do not determine snow/sea ice in coastal regions. This can result in an incorrect snow/ice-free “ring” around coasts. In particular, rings of erroneously large cloud optical thickness retrievals were noticeable around Greenland in Collection 004 data (i.e., small surface albedos used when snow/ice was actually present). As a workaround, Rich Frey (University of Wisconsin/CIMSS) implemented an interpolation technique using surrounding non-coastal pixels in combination with the NOAA sea ice product. With this technique, non-permanent snow land/water pixels originally flagged as snow/ice-free can be reset to be snow covered. This technique has been tested in MOD35 production, and was implemented in the Collection 005 MOD06OD delivery. Spectral albedos for the reset land pixels are assigned their MOD12Q1 ecosystem-dependant snow albedo value from the snow statistics lookup table; reset water pixels are appropriately processed as sea ice.

- **Updated IGBP ecosystem map.** The static MOD12Q1 IGBP ecosystem classification map used in MOD06 retrievals was updated to the most recently produced version. MOD12Q1 production occurs off-line when a significant number of observations can be used to update the classifications. In the previous operational map, urban areas were not properly represented. Besides updating the majority of land surfaces, the revised MOD12Q1 processing algorithm addressed the urban issue such these areas are now fully represented.
- **Surface type & surface albedo matching.** The MOD06 surface albedo reader code was modified to return surface type (land/water/snow-ice) index values along with the surface albedo data. This ensures that surface type is always consistent with the surface albedo. Close examination of early test results revealed that the surface type processing path reported by the MODIS Cloud Mask (MOD35) could sometimes replace the surface type reported earlier in the algorithm. This could lead to a mismatch between surface albedo and surface type (land/water/snow-ice). It should be noted that the Wisconsin team that authored the Cloud Mask algorithm does not (nor never did) recommend the use of the sur-

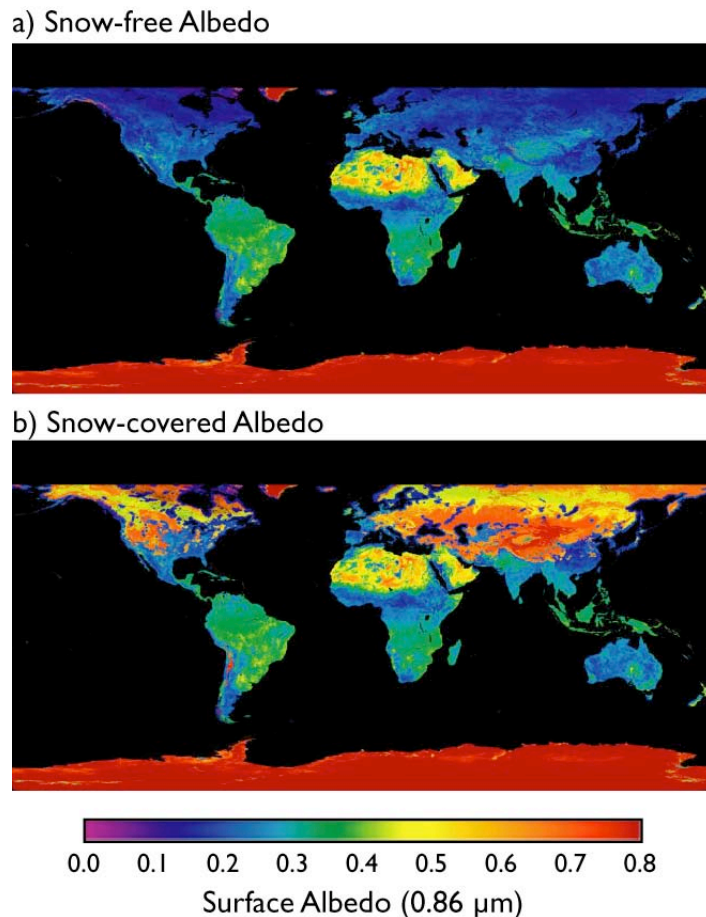

Figure 6. Spatially complete white-sky albedo at 0.86 μm from January 1-16, 2002, without (top) and with (bottom) overlaid 2000-2004 hemispheric snow albedo mean values; permanent snow locations (Antarctica, Greenland) retain their non-static values by using the MOD43B3 retrieved albedo directly and are therefore the same in both figures. See text for further details. Note that variability is visually lost when albedo values greater than 0.8 saturate the color scheme (after Moody et al. 2006b).

face type reported in MOD35 as a surrogate for surface type determination.

Primary Cloud Optical Property Algorithm Improvements

- **Primary cloud optical property retrieval.** When the 5 km Cloud Top Properties retrieval is fill (e.g., if less than 4 out of 25 1-km pixels are identified as “cloudy” by the cloud mask product) the cloud optical property retrieval is not attempted and pixels are assigned the fill value.
- **Effective radius solution logic.** A new spline interpolation for the effective radius solution was implemented.
- **Eliminate saturation and failed retrievals for large cloud optical thickness.** If the 0.86 μm band measurement saturates for ocean retrievals (common for Terra MODIS), the 0.66 μm band is used instead. If cloud optical thickness ≥ 100 and indeterminate, effective radius is still retrieved (well-determined for optically thick clouds). Set the *Band Used for Primary Optical Thickness Retrieval* flag in processing (runtime) QA. [Figure 7 shows a Collection 005 retrieval example of a west African granule with both liquid water and ice clouds over land and ocean, in which Collection 005 retrievals do not fail over thick ice clouds where Collection 004 was saturated and had failed. In addition, sunglint contamination in Collection 004 was

properly screened out in Collection 005.]

a) R(0.645,0.555,0.469)

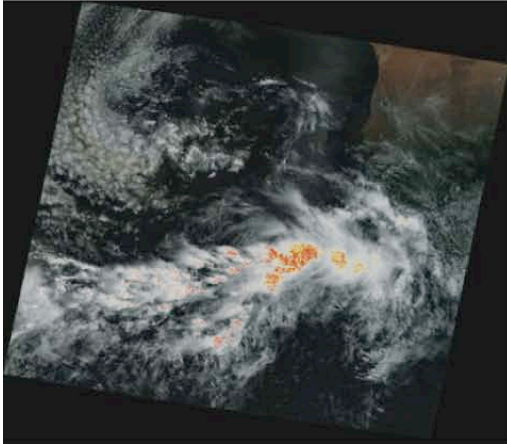

b) Cloud Optical Thickness (C004)

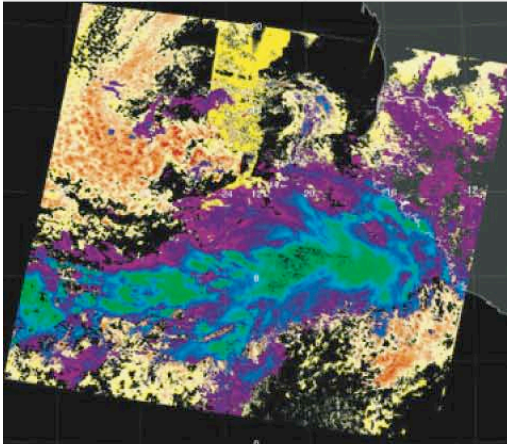

c) Cloud Optical Thickness (C005)

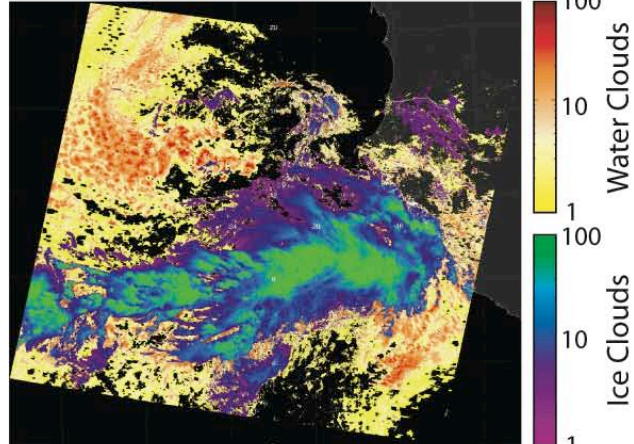

d) Cloud Effective Radius (μm) (C004)

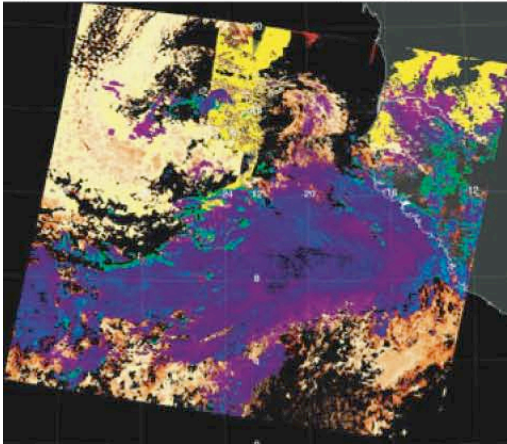

e) Cloud Effective Radius (μm) (C005)

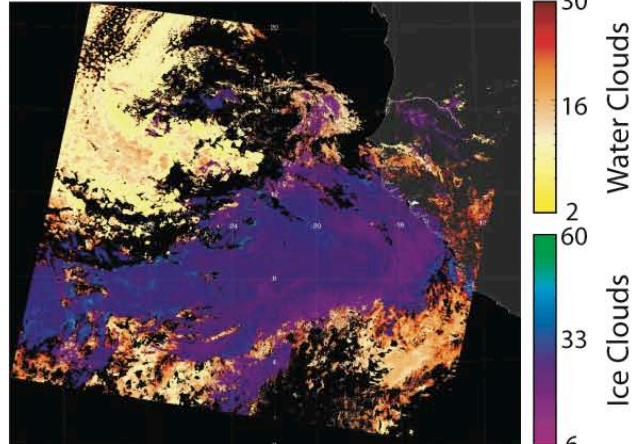

Figure 7. Cloud optical thickness and effective radius retrieved from Terra MODIS on July 25, 2001 over west Africa and the nearby Atlantic Ocean. This figure shows (a) the true color image that shows a region of problematic ocean sunglint and low level dust outflow from the African continent, (b) and (c) the cloud optical thickness for Collection 004 and 005, and (d) and (e) the cloud effective radius for Collection 004 and 005. The primary improvements depicted are: (i) correct handling of ocean sunglint (no longer misidentified as cloud in Collection 005), (ii) correct handling of dust over land (no longer misidentified as cloud in Collection 005), and (iii) a marked reduction in failed retrievals (esp. in the middle of the thick ice cloud).

- **Removal of 0.0 cloud optical thickness.** If a cloud optical thickness less than 0.005 is computed, it is stored in the 06_L2 file as 0 (due to integer*2 packing (digitizing)). This was causing a problem in the Level-3 algorithm in the log of cloud optical thickness computation (since log 0 is undefined). The Level-2 retrieval for cloud optical thickness was hardwired to 0.01 for numbers computed less than 0.01. The cloud retrievals are affected such that there are no more cloud optical thickness retrievals of integer value of 0 stored in the HDF file (i.e., falling between 0 and 0.01).
- **New solar zenith angle threshold.** The solar zenith angle must be less than 81.4° ($\mu_0 > 0.15$) to attempt a retrieval. The threshold had been 87° for Collection 004 and earlier. This was done, in part, so that the cloud optical property retrieval region better matches the “day-light” region used by the Cloud Mask. This eliminated the no retrieval “ring” that was visible in Level-3 global cloud optical property maps near the polar darkness zone.
- **Cloud Water Path formula.** A bug existed in the calculation of cloud water path in Collection 004; a constant pre-factor was incorrectly set to $3/4$ rather than $2/3$. This bug affected the computation of Cloud Water Path for both liquid water and ice clouds. For ice clouds, an incorrect ice density of 1.0 g-cm⁻³ was used in the Collection 004 formula; Collection 005 uses an ice density of 0.93 g-cm⁻³, further reducing the water path value for the same cloud optical thickness (τ_c) and effective particle radius (r_e). Finally, the variation of extinction with wavelength and r_e has been incorporated into the water path formula. To summarize, with Q_e as the extinction efficiency at the same reference wavelength used to report the optical thickness retrieval (MODIS band 2, 0.65 μm), the Collection 005 Cloud Water Path is computed as:

$$\text{Cloud Liquid Water Path} = 4/(3Q_e(r_e)) \tau_c r_e$$

$$\text{Cloud Ice Water Path} = 0.93 * 4/(3Q_e(r_e)) \tau_c r_e$$

- **Liquid water cloud effective radius range.** The range of acceptable effective radius retrievals for liquid water clouds is 4-30 μm in Collection 005 (vs. 2-30 μm in Collection 004).

3.7 μm Cloud Effective Radius Retrieval

- **Update solar spectral irradiance in 3.7 μm band.** Change the 3.7 μm band-averaged solar irradiance from 11.297 Wm⁻² μm^{-1} (Thekaekara, 1974) to 11.739 Wm⁻² μm^{-1} (Fontenla 2006). After Collection 005 processing began, a bug was reported in the Fontenla model; when fixed, F_0 was reduced to about 11.11 Wm⁻² μm^{-1} (Fontenla, private communication).

Supplementary 1.6/2.1 μm Cloud Optical Property Algorithm Addition (New SDSs)

- **Add supplementary 1.6/2.1 μm cloud optical property retrieval.** In addition to the primary cloud optical property retrieval that has been in place since launch, a new supplementary cloud optical property retrieval using the 1.6 and 2.1 μm bands was added for Collection 005. This new retrieval, computed only for clouds over ocean and snow/ice surfaces, was performed for comparison with the standard retrieval. Three parameters are computed in the cloud optical property retrieval algorithm: cloud optical thickness, cloud effective radius, and cloud water path. This new 1.6 / 2.1 μm retrieval is run over ocean and snow/ice surfaces only, so non-snow land will contain all fill values. (Note that the “ocean” ecosystem also includes deep inland waterways.) The new SDS (short) names are:

Cloud_Optical_Thickness_1621,
Cloud_Effective_Radius_1621,
Cloud_Water_Path_1621.

Atmospheric Transmittance Improvements

- **New transmittance library.** For both Collection 004 and 005, atmospheric transmittance calculations for absorbing species are obtained from MODTRAN 4.2.1 with HITRAN 2001. The Collection 004 table was generated from 6 standard atmospheres. The new table is generated from a statistical aggregation of the ECMWF 60-level profile database (Chevallier 2001). The database contains 13,495 profiles; spatial and temporal resolutions are roughly 1° and 15 days, respectively. Profiles are screened for clouds whereby relative humidity on each of the 60 levels must be less than 98% and cloud fraction for each level must be less than 0.85. The 60-level profiles are re-sampled to 36 levels to match with MODTRAN trace gas profiles. Each ECMWF sounding is matched with the trace gas profile based on its location and time of the year. MODTRAN simulations are then run and 2 nm spectral resolution output is integrated across the channel relative spectral response function. Computations are done for 10 pressure levels, evenly spaced between 100 and 1000 hPa, and 20 slant-path angles (effective round-trip path for solar bands) evenly spaced between 1.0 and 0.05. The table has a fixed set of non-uniform precipitable water entries; each profile is nudged to fit the nearest entry to eliminate binning error during aggregation.
- **Transmittance table and read logic update.** Modified the water vapor path transmittance when the above-cloud precipitable water (PW_c) is beyond the minimum or maximum limits of the transmittance look-up table entries. This has a minimal impact on the retrievals because exceeding the bounds of the transmittance table was an infrequent occurrence in Collection 004.
- **Ozone transmittance correction.** Calculate ozone path transmittance in the Chappuis band using column ozone from TOAST data files. This only affects cloud retrievals over snow-free land where the $0.66 \mu\text{m}$ band is used for cloud optical thickness retrievals. An ozone transmittance correction was not performed separately in Collection 004.

Rayleigh Correction Improvements

- **Rayleigh correction.** Fixes the Collection 004 inadvertent $\tau_c \geq 1$ restriction for cloud retrievals over land that occurred as the Rayleigh correction was being implemented for the $0.66 \mu\text{m}$ band. Also, makes use of the new spatially-complete surface albedo at $0.66 \mu\text{m}$ to implement the Rayleigh correction.

QA Array Changes and Enhancements

- **New quality assurance (QA) array assignments.** Many new QA flags were defined (and some previously un-set flags were deleted) in the Quality_Assurance_1km SDS. Most new flags were related to the $1.6/2.1 \mu\text{m}$ retrieval, multi-layer cloud flag, and new clear-sky restoration. [A newly developed Collection 005 version of the QA Plan detailing all of these changes is available at modis-atmos.gsfc.nasa.gov/docs/QA_Plan_2005_06.pdf.]
- **QA Implementation.** New software logic was implemented such that future updates to the QA flag array can be more easily integrated. New logic now correctly sets QA confidence

flags for Cloud_Water_Path (not set in Collection 004).

- **Set QA confidence flags based on new joint histogram boundaries.** Use a Collection 005 version of QA confidence flag assignments based on a combination of the cloud optical thickness and effective radius retrieval. The QA flag is used for the Level 3 QA-weighted statistics. [For detail, see Diagram 6 at end of document.]

New Uncertainty Analysis (New SDSs)

- **Pixel-level Retrieval Uncertainty.** Estimates for the uncertainty (RMS relative uncertainty normalized to percent) in the cloud optical thickness, effective radius, and water path retrieval were added. Three new SDSs were defined for the primary retrieval:

Cloud_Effective_Radius_Uncertainty,
Cloud_Optical_Thickness_Uncertainty,
Cloud_Water_Path_Uncertainty.

Similarly, three new SDSs were defined for supplementary 1.6 /2.1 retrieval were added:

Cloud_Effective_Radius_Uncertainty_1621,
Cloud_Optical_Thickness_Uncertainty_1621,
Cloud_Water_Path_Uncertainty_1621.

The uncertainty estimate accounts for three error sources only, and as such should be considered an expected minimum uncertainty, i.e., the inclusion of additional (uncorrelated) error sources will increase the uncertainty.

The relative surface spectral albedo uncertainty is assumed to be 15% of the pixel-dependent surface albedo value, for all spectral bands. Calibration and model uncertainty are combined into a single error source that is set to 5% relative for all spectral bands. The relative uncertainty in the above-cloud precipitable water amount (derived from model analysis and the MODIS cloud-top pressure retrieval) is assumed to be 20%; this partial column water vapor amount is used for atmospheric corrections that infer cloud-top radiances in all relevant spectral bands. These uncertainties for individual retrieval error components fundamentally impact the resulting retrieval uncertainty calculation for cloud optical thickness, effective radius, and water path, all of which are new in Collection 005. [Figure 8 shows Collection 005 retrievals and uncertainties for a data granule over the bright Greenland continent and nearby ocean where some clouds overly sea ice.]

New Multi-layer Cloud Detection Algorithm (New SDSs)

Multilayer cloud detection. A new research-level algorithm for the detection of multiple cloud layers was implemented. The information is stored in two places. An SDS named “Cloud_Multi_Layer_Flag” contains information about the results of the various tests that comprise the algorithm. A value of 1 indicates a single-layer cloud (i.e., all multilayer tests were negative); a value of 0 indicates a clear sky pixel. Pixels flagged as having multiple cloud layers are assigned integer values from 2 through 9, with larger integers generally indicating a higher confidence in the existence of multiple layers. In addition, the multilayer result is combined with cloud phase information to produce a new QA flag named *Primary Cloud Retrieval Multilayer Cloud & Phase Flag* that is stored in the “Quality_Assurance_1km”

a) $R(0.645, 0.555, 0.469)$

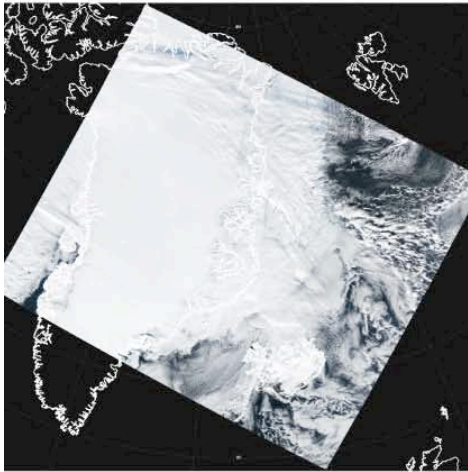

b) Thermodynamic Phase

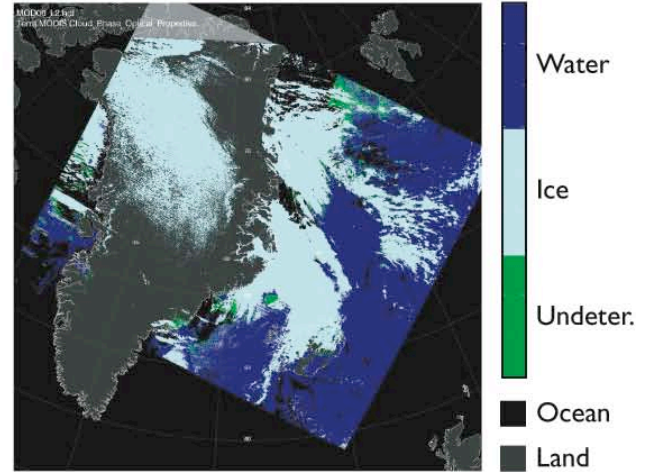

c) Cloud Optical Thickness

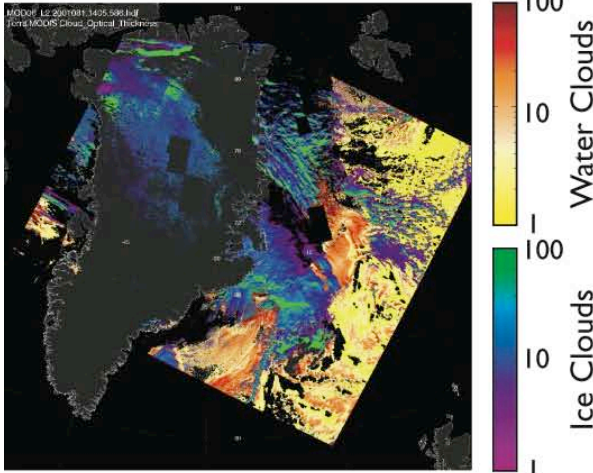

d) Cloud Effective Radius (μm)

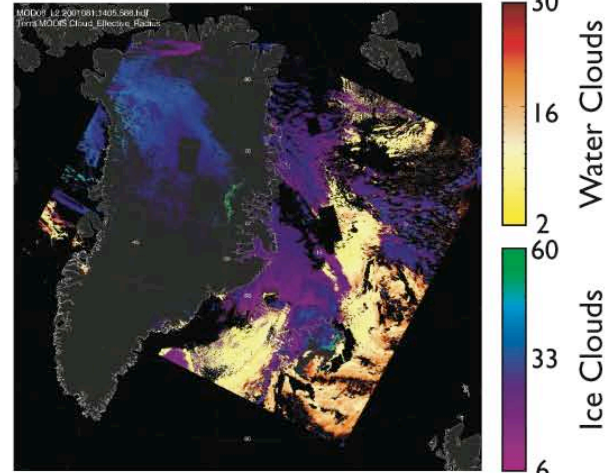

e) τ_c Uncertainty (%)

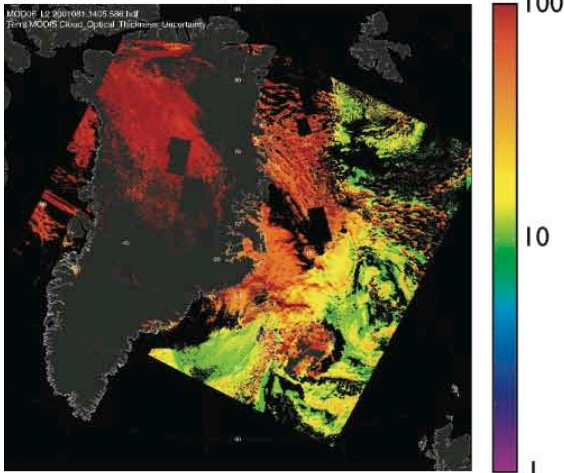

f) r_e Uncertainty (%)

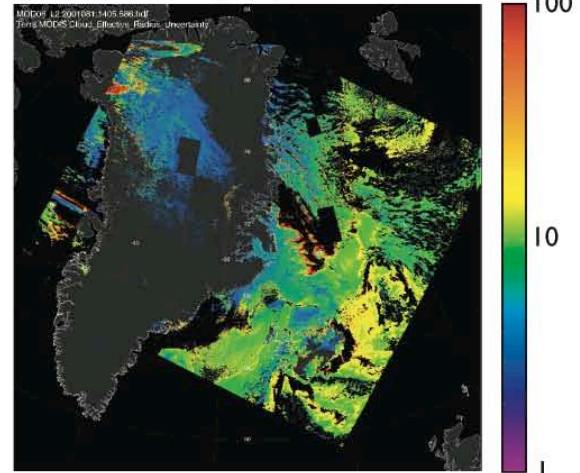
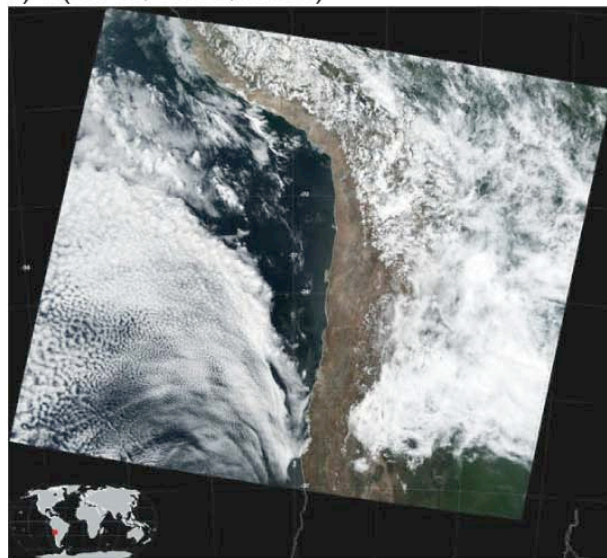

Figure 8. Cloud optical thickness and effective radius retrieved on March 22, 2001 over Greenland and the nearby Atlantic Ocean for a Terra MODIS data granule. This figure shows (a) the true color image where it is difficult to distinguish clouds from snow and sea ice, (b) the thermodynamic phase of all clouds identified for this scene, (c) the cloud optical thickness of liquid water and ice clouds, and (d) cloud effective radius of liquid water and ice clouds. Panels (e) and (f) show results from the new pixel-level uncertainty algorithm applied to this scene (log color scale in percent uncertainty).

a) R(0.645, 0.555, 0.469)



b) Multilayer Cloud & Phase (QA) Flag

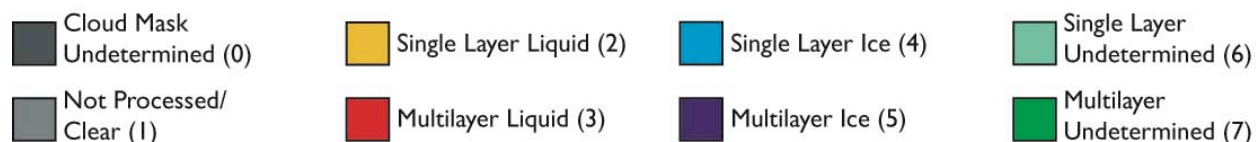
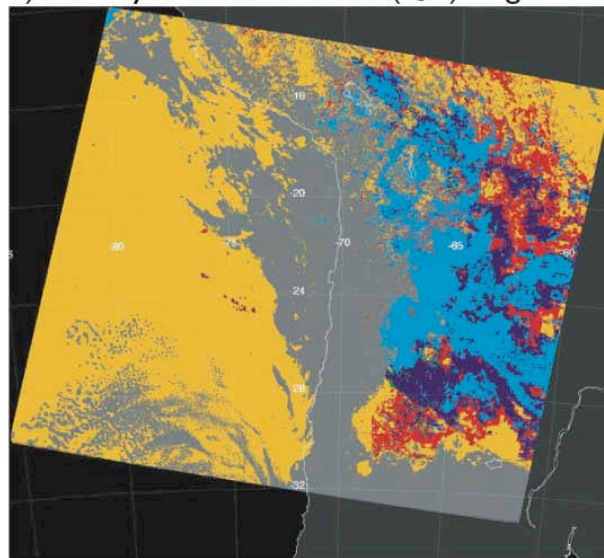

Figure 9. Multilayer cloud detection. Panel (a) is a true color composite of a Terra MODIS granule off Peru on February 12, 2001 at 15:10 UTC. Panel (b) is the new Collection 005 Multilayer Cloud & Phase Flag that is stored in the Cloud Optical Properties QA Flag array (Quality_Assurance_1km SDS). The research-level flag indicates the result of a multilayer cloud detection algorithm according to the thermodynamic phase of the pixel used for the optical thickness and effective radius retrieval (notation: 1L = single layer cloud, ML = multiple layers of clouds).

SDS. Values range from 0 through 7, with 0 and 1 corresponding to clear and/or unprocessed pixels. All even values (2, 4, 6) correspond to single layer clouds of water, ice and undetermined phase, respectively. All odd values (3, 5, 7) correspond to multi-layer clouds processed as if they were single layer water, ice and undetermined phase, respectively. The QA flag is used by the Level-3 code to separately aggregate single layer and multilayer cloud fraction, as well as single layer retrievals. [Figure 9 shows an example of this new flag]. [For detail on reading the QA flag noted above, see page 21 of the Collection 005 version of the QA Plan at modis-atmos.gsfc.nasa.gov/docs/QA_Plan_2005_06.pdf.

New Stand-alone Cloud Phase SDS

- **A separate SDS for cloud phase was implemented.** A new SDS with (short) name “Cloud_Phase_Optical_Properties” was defined. This new SDS duplicates information previously stored only as a QA flag (Primary Cloud Retrieval Phase Flag) in the “Quality_Assurance_1km” SDS. This information was duplicated and separated into a stand-alone SDS to make it more accessible to users. Note that cloud phase information is still available in the QA flag array in Collection 005.

Existing SDS Name Changes

- **Renamed SDSs.** Two SDS name changes were implemented in Collection 005:

Effecitve_Particle_Radius was changed to Cloud_Effective_Radius, and Water_Path was changed to Cloud_Water_Path.

These changes were made to make the content of these data sets more obvious to users.

Inventory Metadata Correction

- **Inventory metadata implementation.** Inventory metadata computation errors were detected and fixed. Inventory Metadata are searchable strings, stored within each HDF file, which can be used to assist users to select granules that meet predetermined criteria. Four percentages are computed for each and every MOD06 granule (HDF file):

SuccessCloudOptPropRtrPct_VIS (*successful retrievals only*),
CloudCoverFractionPct_VIS (*successful & unsuccessful retrievals*),
WaterCloudDectedPct_VIS (*successful & unsuccessful retrievals*),
IceCloudDetectedPct_VIS (*successful & unsuccessful retrievals*).

[For detail on reading these inventory metadata strings, see Appendix B of the Collection 005 version of the QA Plan at modis-atmos.gsfc.nasa.gov/_docs/QA_Plan_2005_06.pdf.]

Miscellaneous Improvements

- **Usable Level-1b reflectance measurement check.** Added a check on the band-specific values of the Level-1b reflectance measurement uncertainty index (stored in the Level-1b HDF file in SDS names: “EV_1KM_RefSB_Uncert_Indexes”, “EV_500_Aggr1km_RefSB_Uncert_Indexes”, and “EV_250_Aggr1km_RefSB_Uncert_Indexes”). These Level-1b SDSs are used, in part, to avoid processing failed 1.6 μm (band 6) detectors on the Aqua MODIS instrument, and will also come into play should other band detectors fail during the life of Aqua MODIS and/or Terra MODIS. This uncertainty index has a valid range from 0 to 15. Values of 0 to 14 denote increasing levels of relative uncertainty in the reflectance measurement. An index of 15 denotes an unusable (failed) detector with no specified uncertainty. In the Level-2 Cloud Optical Properties algorithm (for either Aqua or Terra), a cloud optical and microphysical retrieval (i.e., optical thickness, effective radius, water path) that uses a Level-1b reflectance measurement having an uncertainty index of 15 is not processed and the corresponding Level-2 Cloud Optical Property SDS is set to the fill value (-9999).
- **Correct handling of fill value geolocation.** Fill value (missing) geolocation points were being reported as fatal errors in the ancillary module code. This has been addressed. The code now correctly identifies such points and sets ancillary fields to the fill value; subsequent retrievals fail without impacting the granule as a whole

References:

- Baum, B. A., P. Yang, A. J. Heymsfield, S. Platnick, M. D. King, Y. X. Hu, and S. M. Thomas, 2005: Bulk scattering properties for the remote sensing of ice clouds. 2: Narrowband models. *J. Appl. Meteor.*, **44**, 1896-1911.
- Chevallier, F., 2001: Sampled databases of 60-level atmospheric profiles from the ECMWF analyses,

Fontenla, J. M., E. Avrett, G. Thuillier, and J. Harder, 2006: Semiempirical models of the solar atmosphere. I. The quiet- and active sun photosphere at moderate resolution. *Astrophys. J.*, **639**, 441-458.

Moody, E. G., M. D. King, S., Platnick, C. B. Schaaf, and F. Gao, 2005: Spatially complete global spectral surface albedos: Value-added datasets derived from Terra MODIS land products. *IEEE Trans. Geosci. Remote Sens.*, **43**, 144-158.

_____, _____, C. B. Schaaf, D. K. Hall, and S. Platnick, 2006a: Northern Hemisphere five-year average (2000-2004) spectral snow albedos: Statistics computed from Terra MODIS land products. Submitted to *J. Climate*.

_____, _____, S. Platnick, and C. B. Schaaf, 2006b: Temporal and spatial trends in the MODIS-derived spatially complete global spectral surface albedo products. Submitted to *J. Climate*

Thaekakaera, M. P., 1974: Extraterrestrial solar spectrum, 3000-6100 Å at 1-Å intervals. *Appl. Opt.*, **13**, 518-522.

Diagram 1. Cloud Mask Initial Phase Determination Algorithm: Logic Flow Charts

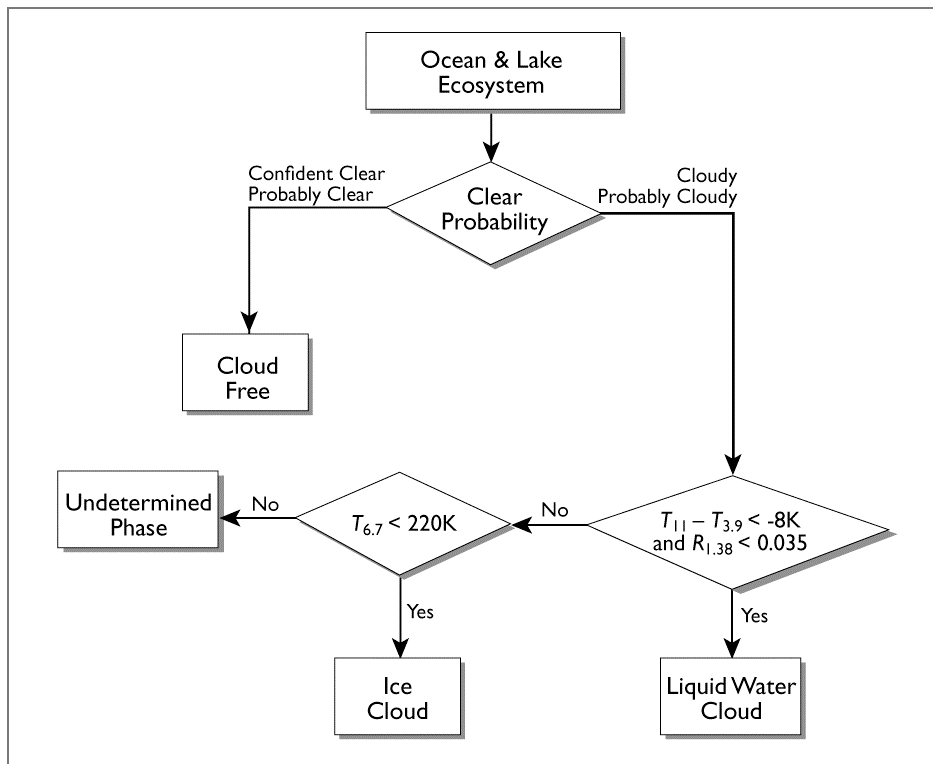
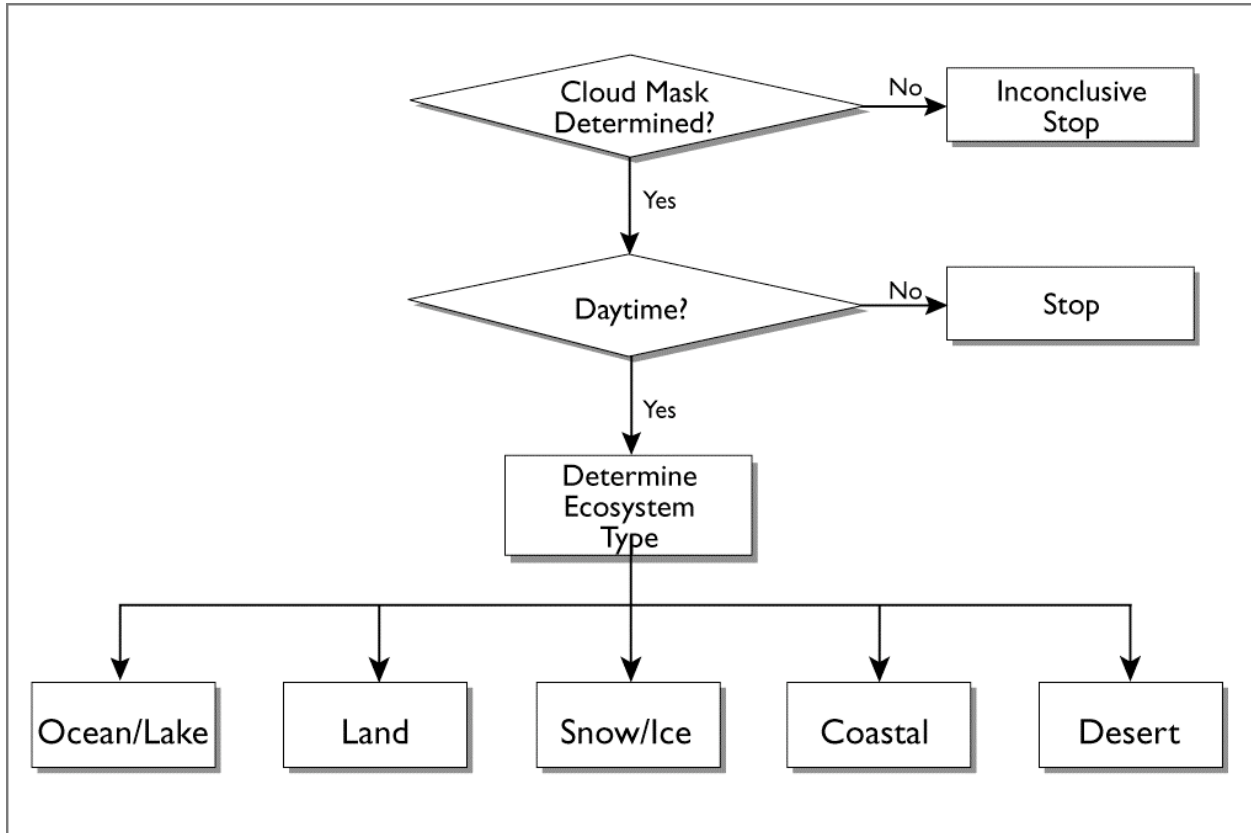

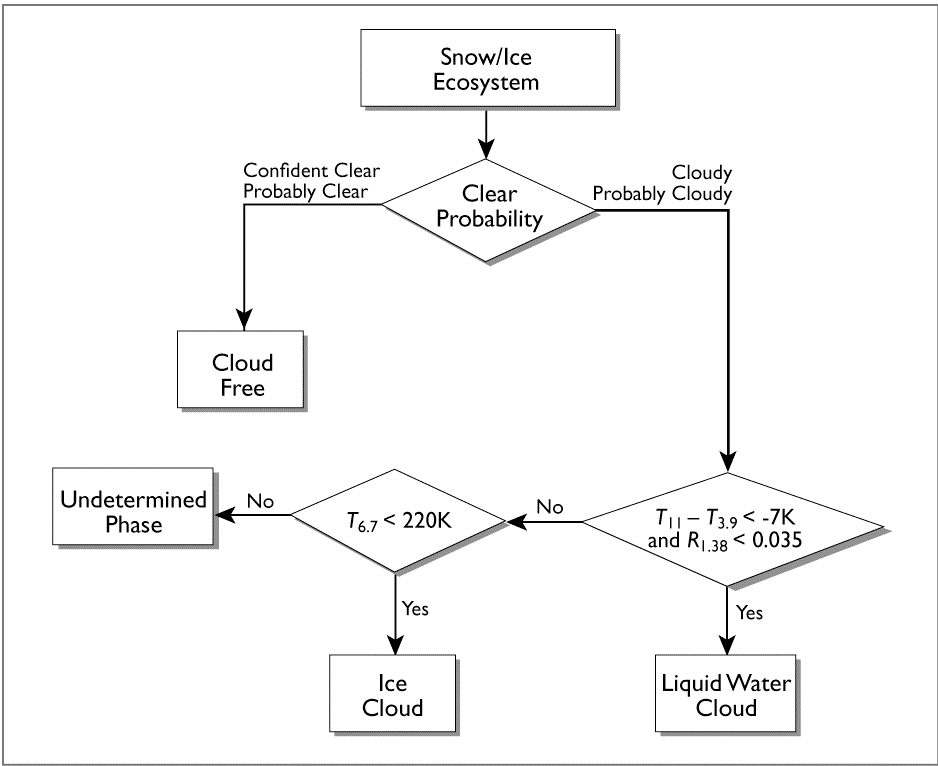
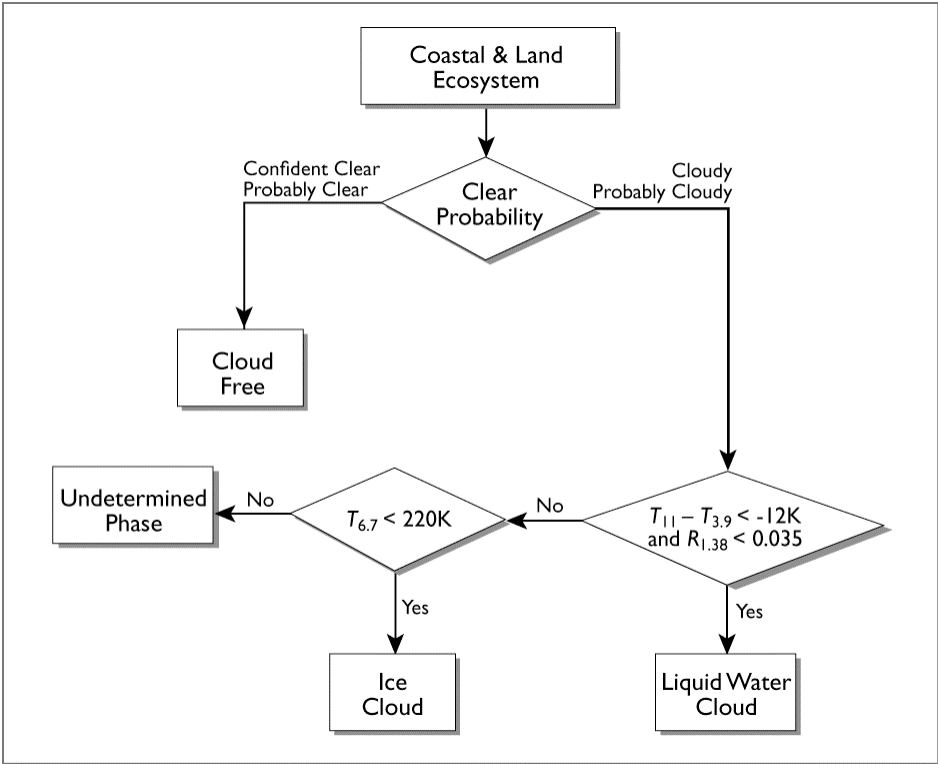

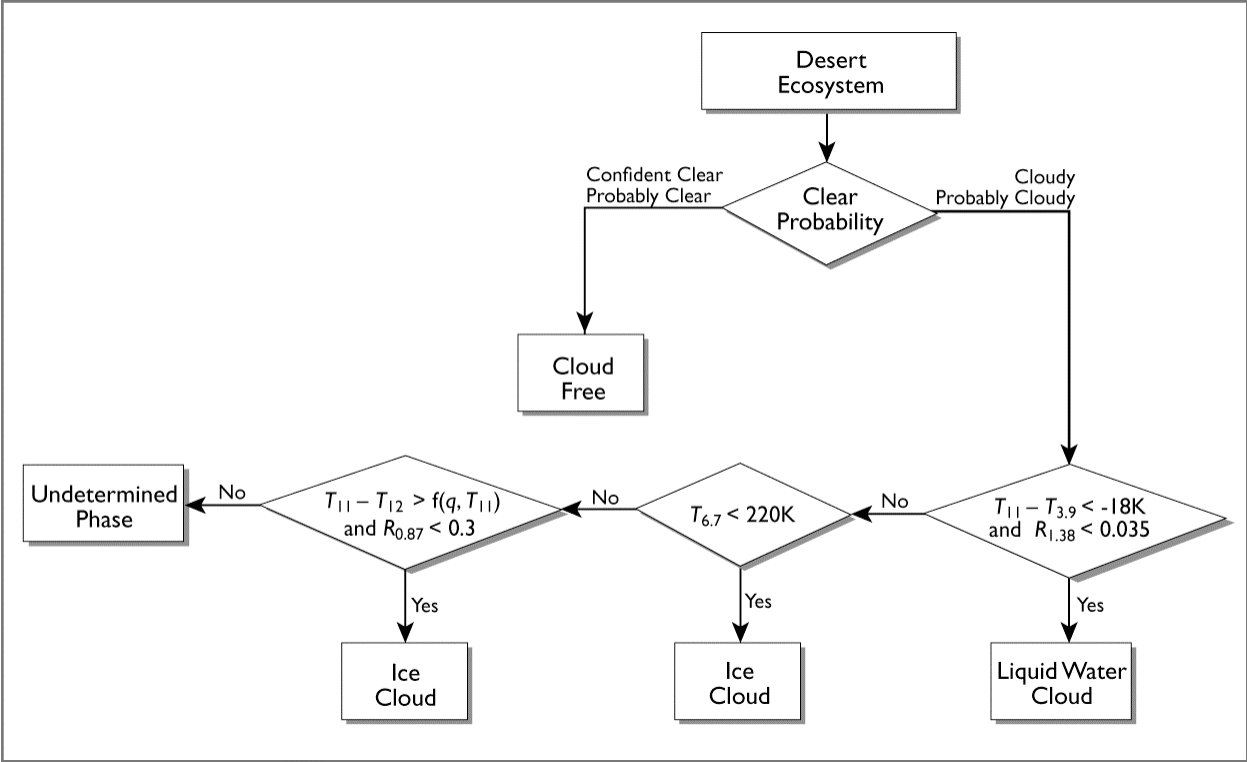

Diagram 2. Primary Cloud Retrieval Phase Algorithm: Logic Flow Chart

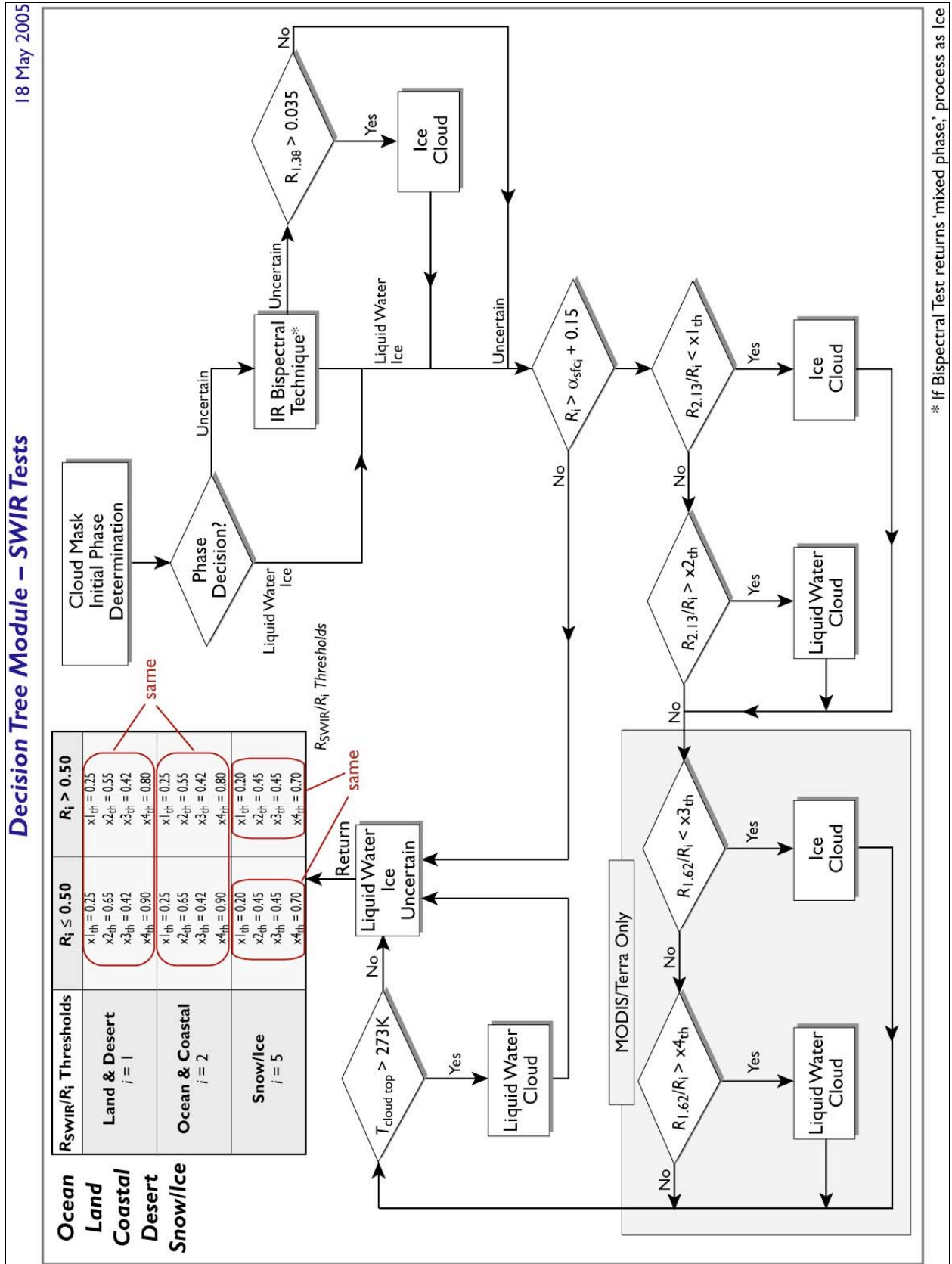
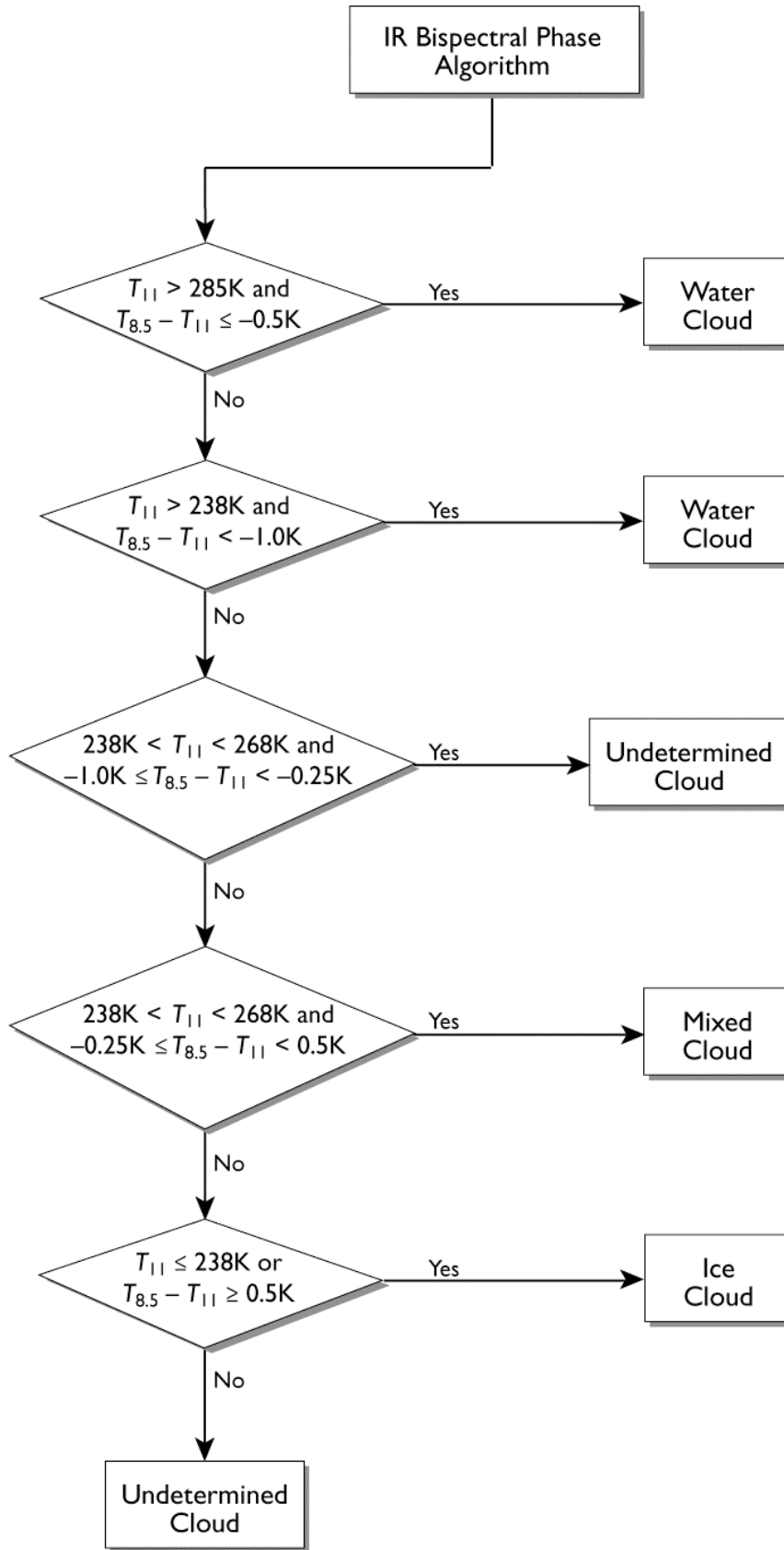

Diagram 3. IR Bispectral Phase Algorithm: Logic Flow Chart†



†Identical Logic to the 5 km SDS called Cloud_Phase_Infrared, but implemented at 1 km as part of the overall Cloud_Phase_Optical_Properties SDS.

Diagram 4. Clear-Sky Restoral Algorithm (part 1): Logic Flow Chart

collection 005

Clear-Sky Restoral (CSR) Module, p. 1

default setting: CSR QA bit value = 0

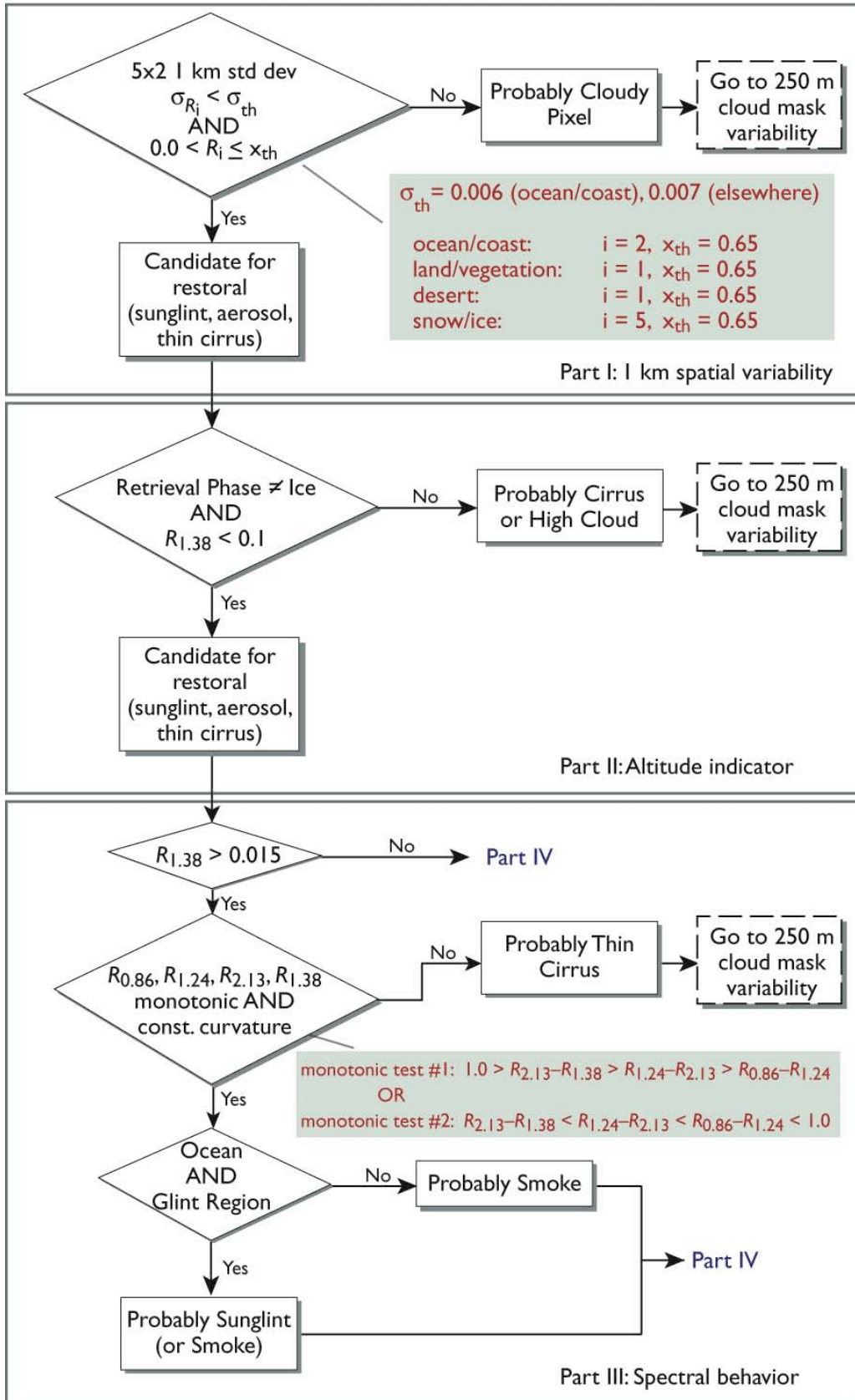

Diagram 5. Clear-Sky Restoral Algorithm (part 2): Logic Flow Chart

Clear-Sky Restoral (CSR) Module, p. 2

collection 005

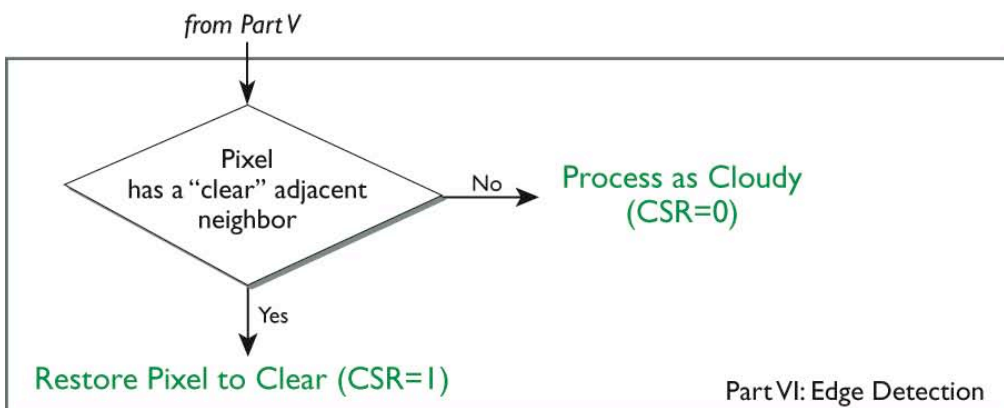
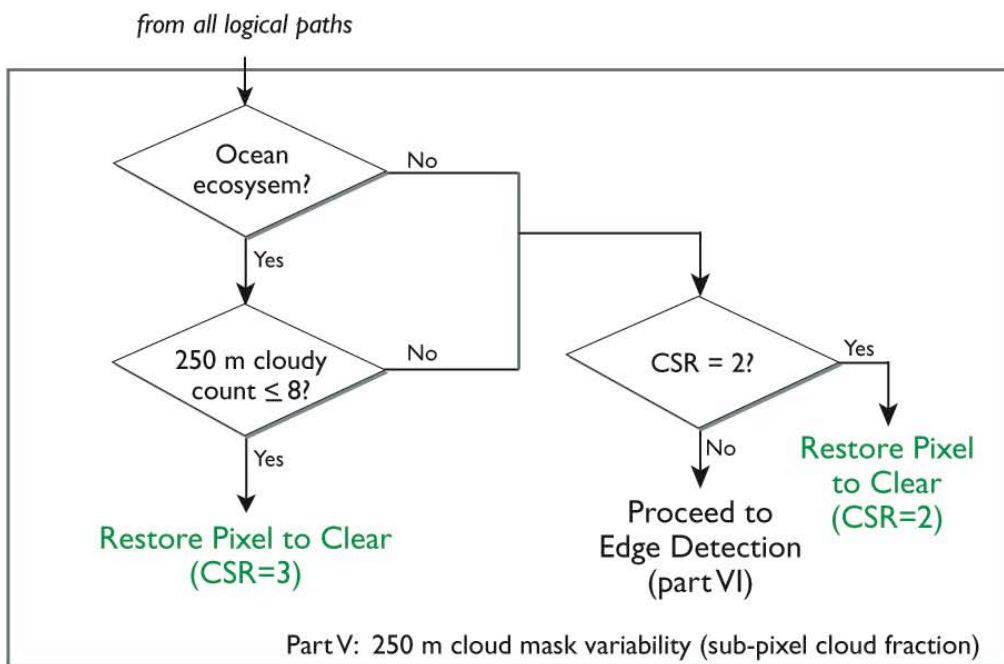
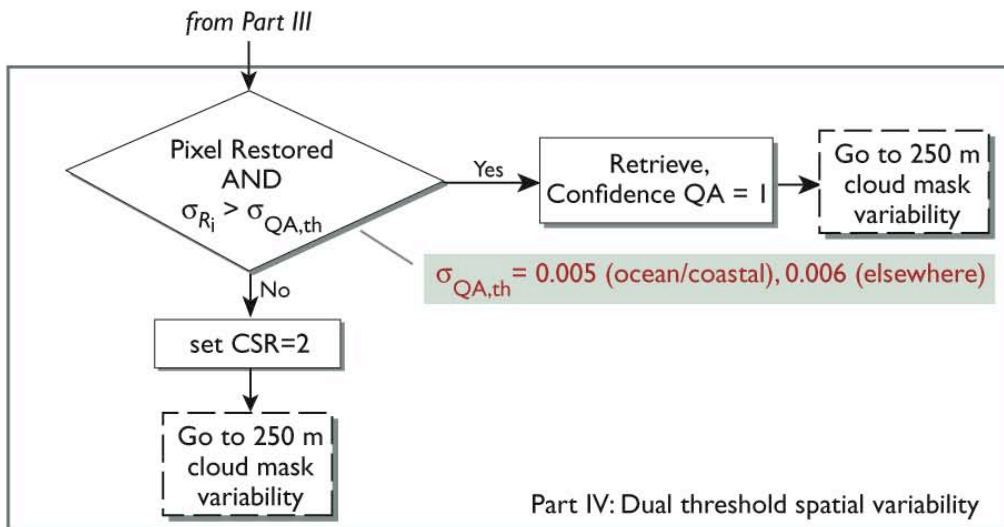

Diagram 6. QA Confidence Flag Assignment Diagrams

Cloud Retrieval QA Confidence Flag Assignments
 (3 = very good, 2 = good, 1 = marginal, 0 = no confidence)

